

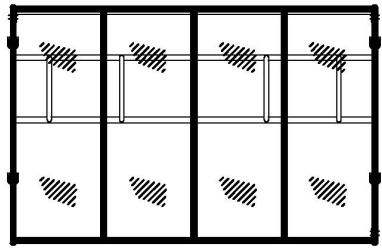

THIS COPY HAS BEEN MADE BY OR WITH THE AUTHORITY OF APPELLATE DISTRICT COURTS PURSUANT TO SECTION 47 OF THE COPYRIGHT DESIGN AND PATENTS ACT 1988, UNLESS THAT ACT PROVIDES A RELEVANT EXCEPTION TO COPYRIGHT. THIS COPY MUST NOT BE COPIED WITHOUT THE PRIOR PERMISSION OF THE COPYRIGHT OWNER.

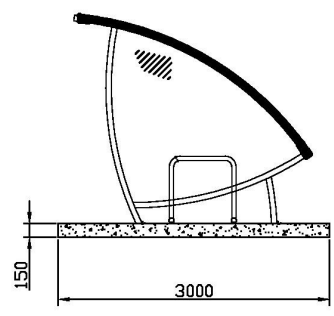

Powder Coated  
colour: Silver RAL9006

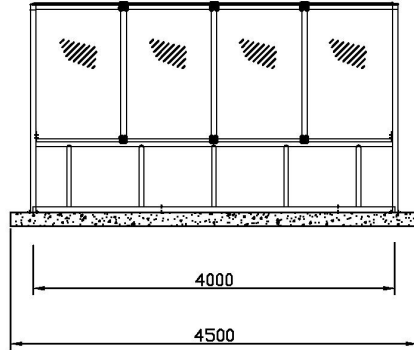

DATE VALID  
10/05/16

 Falco Avenida 11, Avenida 11 28130 San Juan de los Rios, Sevilla Spain	Name	Falco Sall	Scale	NTS	EM
	Article Number	1 bay 4m	Format	A4	
			Date	4/10/07	
			Drawn By	BD	
			Issue	YES	
			Drawing No.		

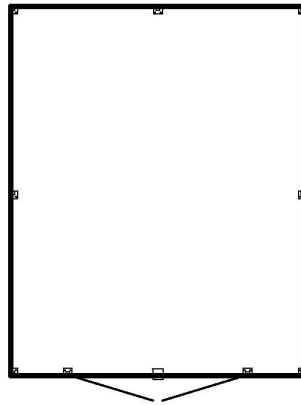

THIS COPY HAS BEEN MADE BY OR WITH THE AUTHORITY OF RYEGATE DISTRICT COUNCIL PURSUANT TO SECTION 47 OF THE COPYRIGHT DESIGNS AND PATENTS ACT 1988. UNLESS THAT ACT PROVIDES A RELEVANT EXCEPTION TO COPYRIGHT, THIS COPY MUST NOT BE COPIED WITHOUT THE PRIOR PERMISSION OF THE COPYRIGHT OWNER.

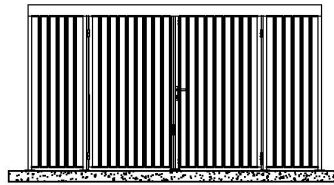
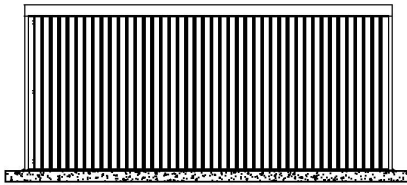

DATE VALID  
10/05/16

 <small>Falco Ltd Preston, Lancashire, UK Tel: 01773 820000 Fax: 01773 820001</small>	Name	FalcoLok-500	Scale	NTS	ES
	Article Number	Bln Store	Format	A4	
			Date	14/12/10	
			Drawn By	BD	
			Issue	YES	
		Drawing No.			